

Varenummer: 203180M24100B3V

Beskrivelse: E+G Justerfod
GN 31-80-M24-100-B3-V

Note: V Uden møtrik, udvendig sekskant i toppen, spændeflade i bunden

Mål

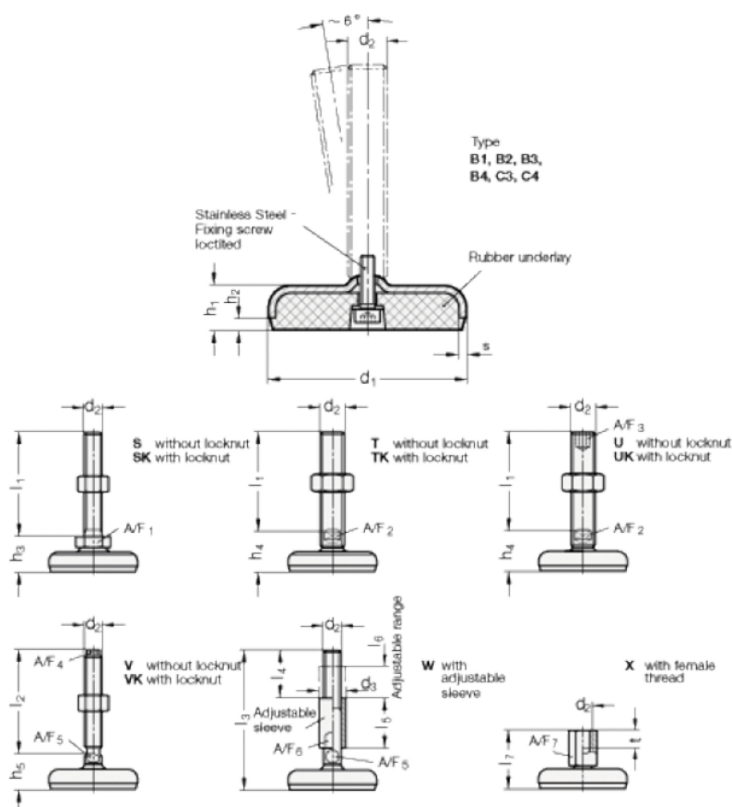

A/F4	= 17
A/F5	= 20
d1	= 80
d2	= 24
h1	= 18
h2	= 5
h5 +4.0/0	= 33
l2	= 100

s = 3